

FNP

15°-90°

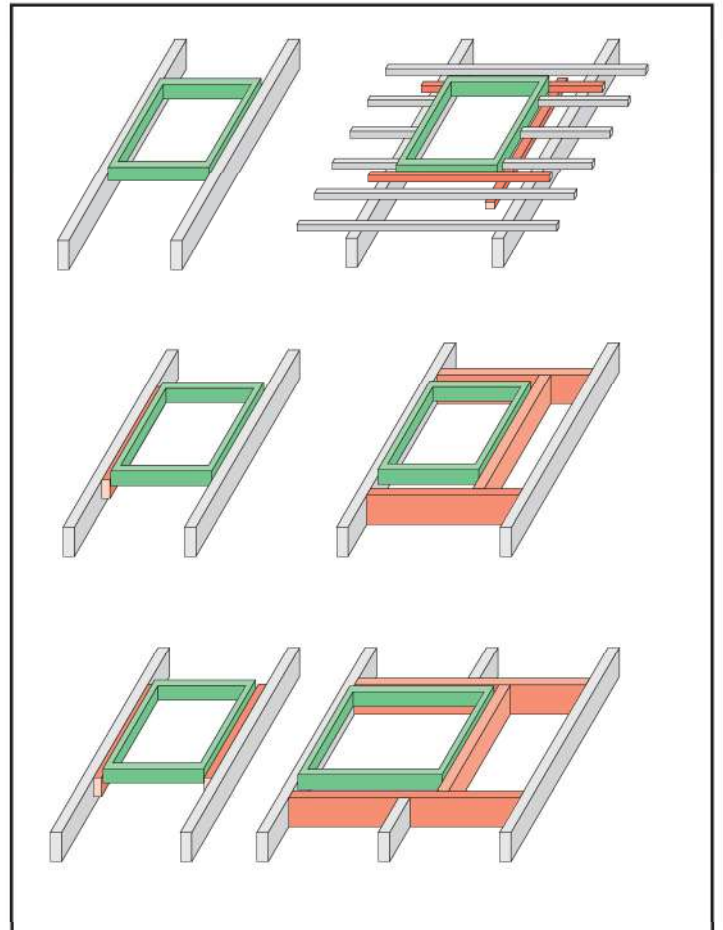

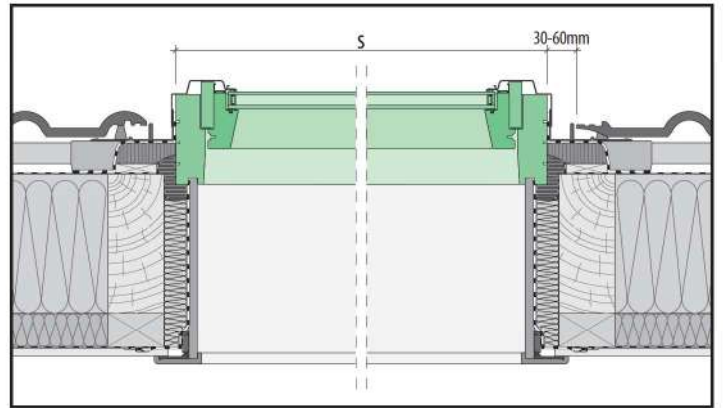

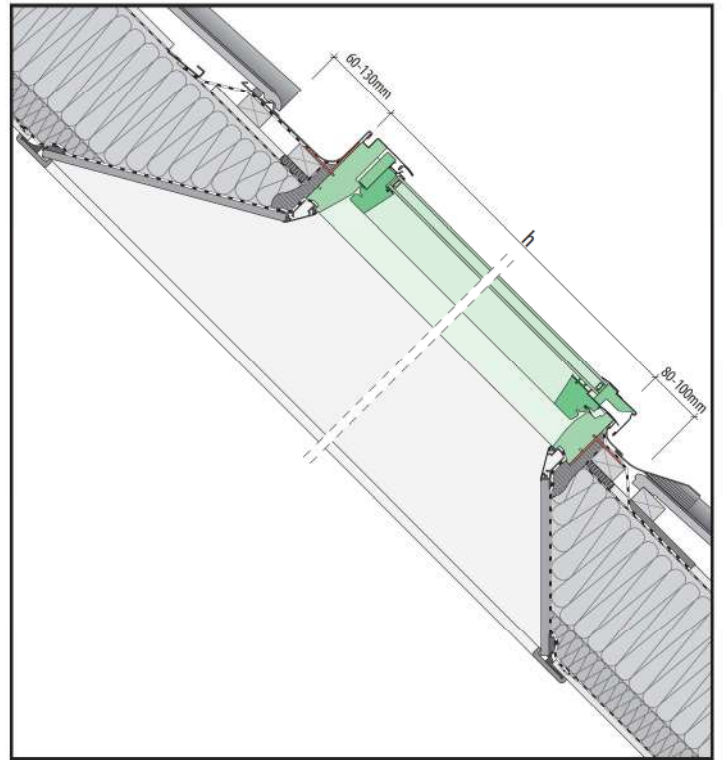
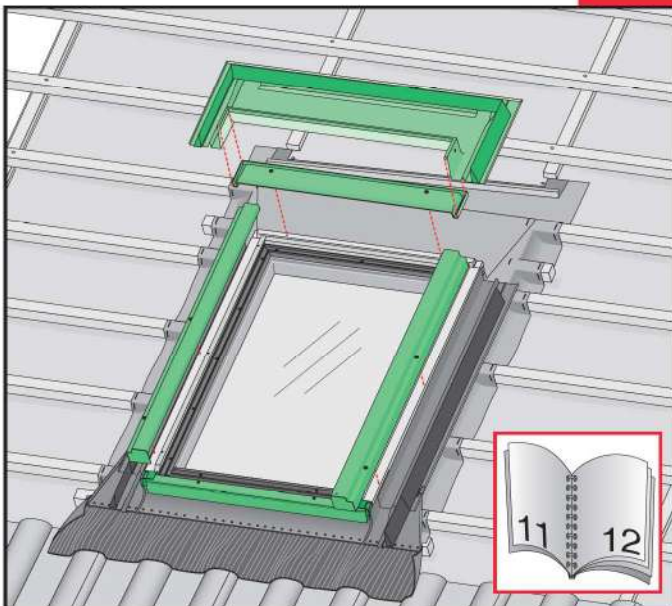
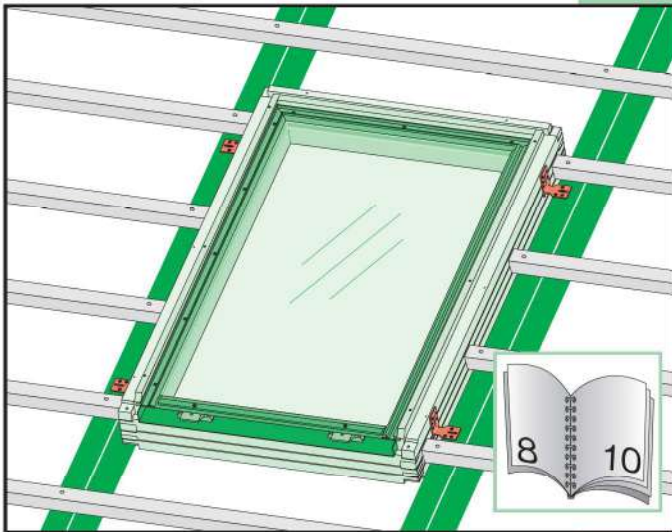
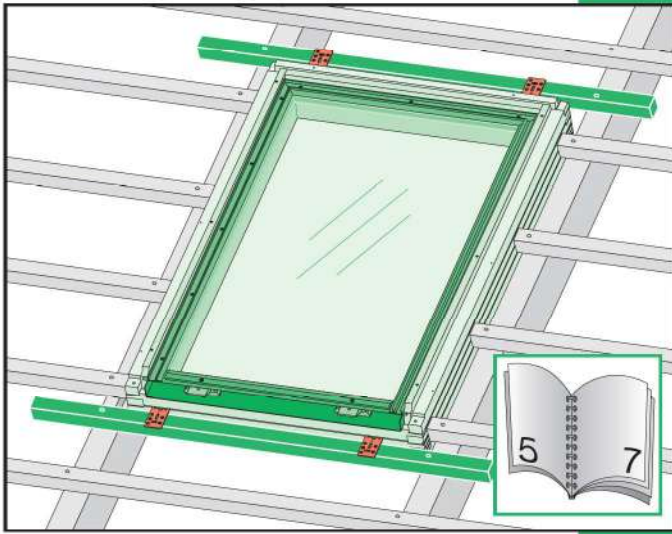
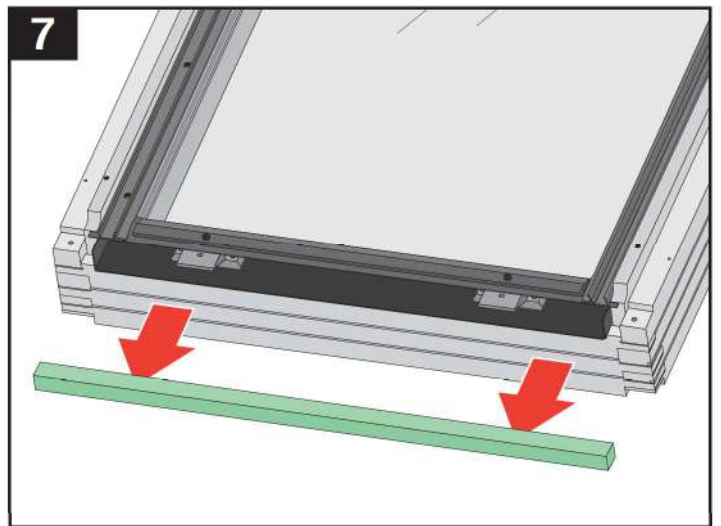
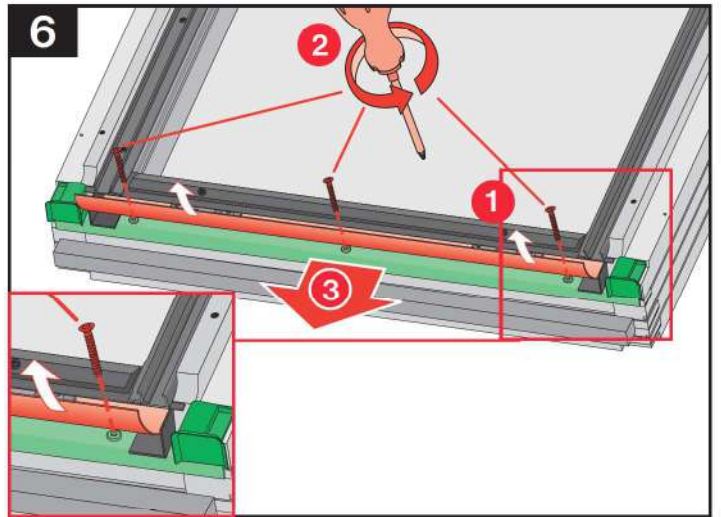
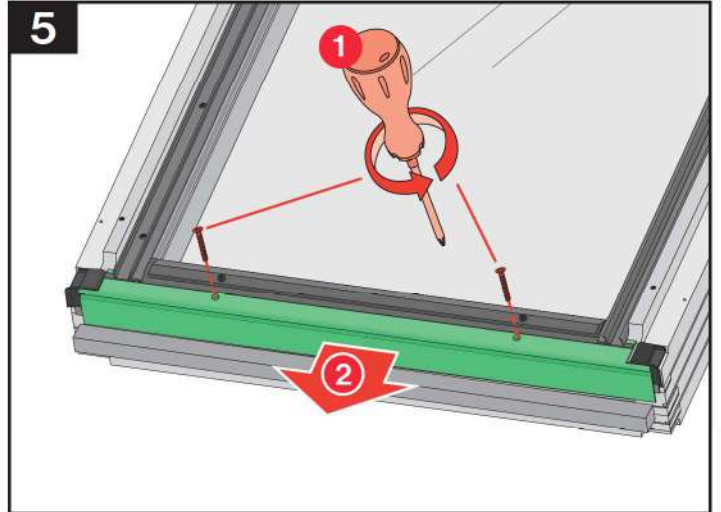
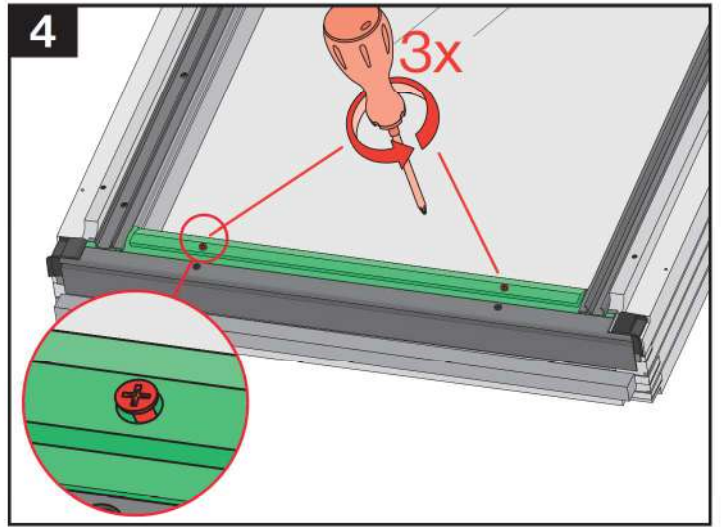
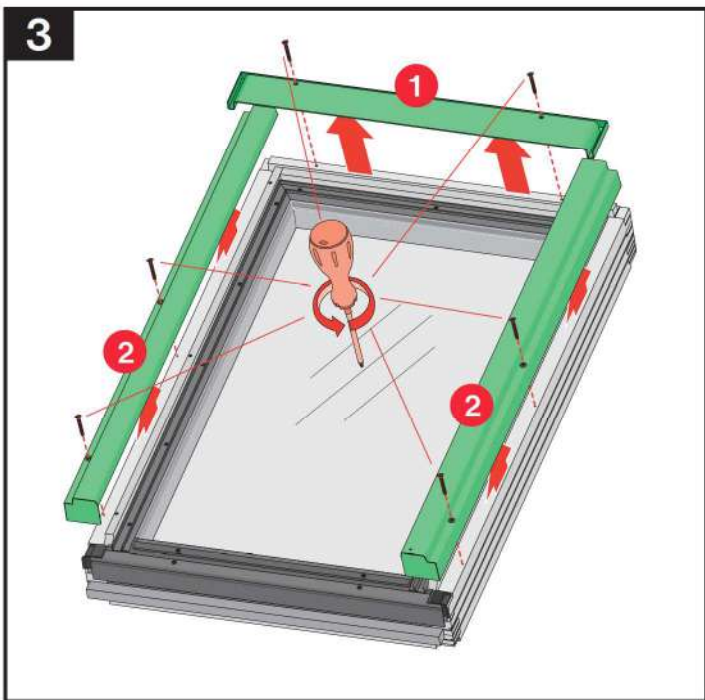
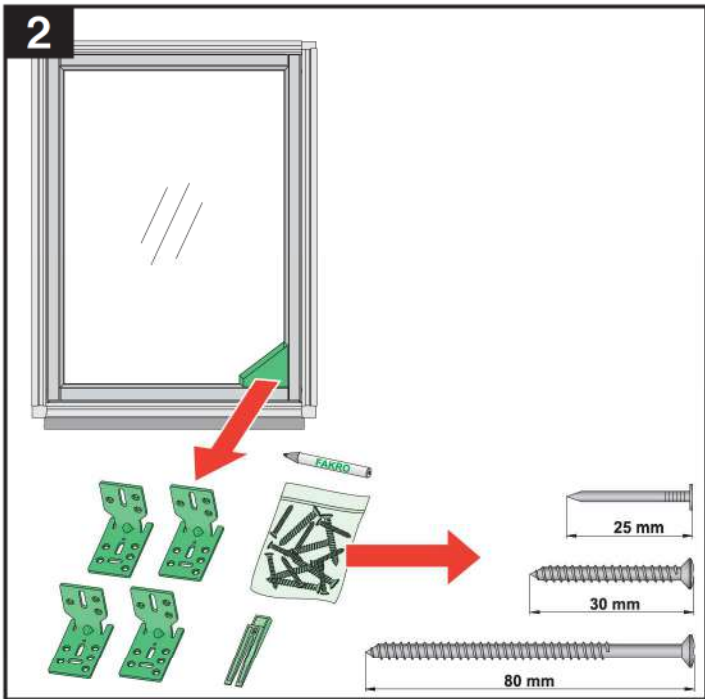
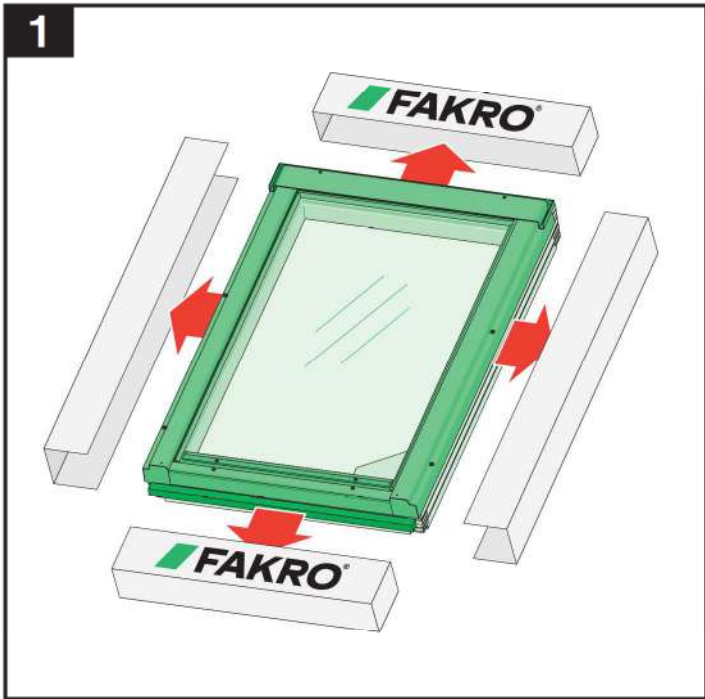
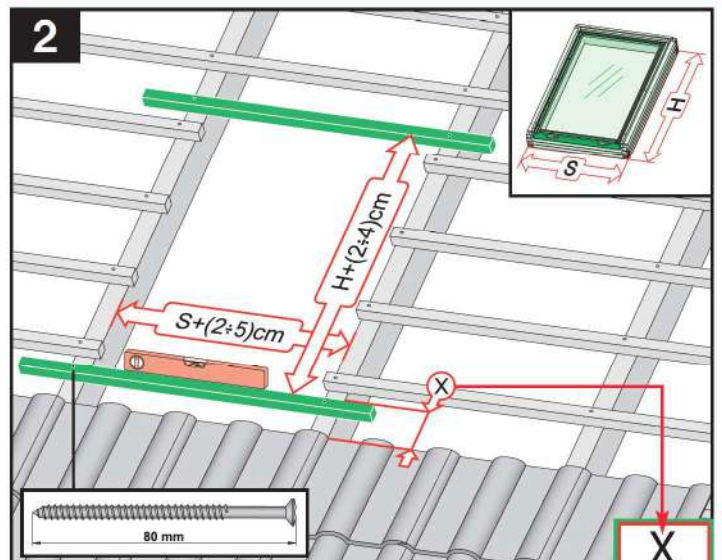
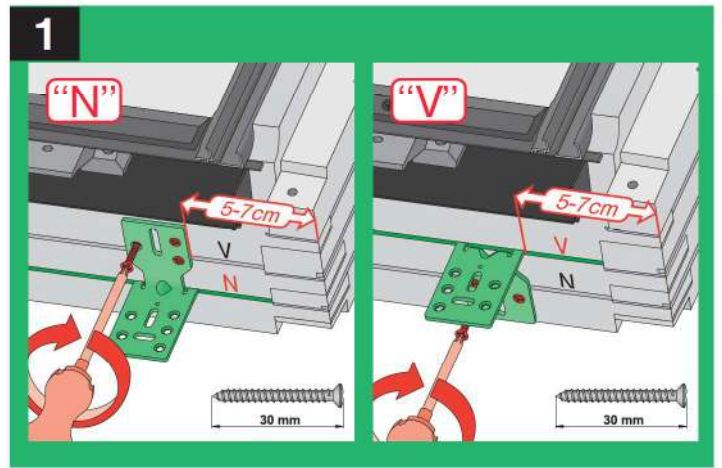
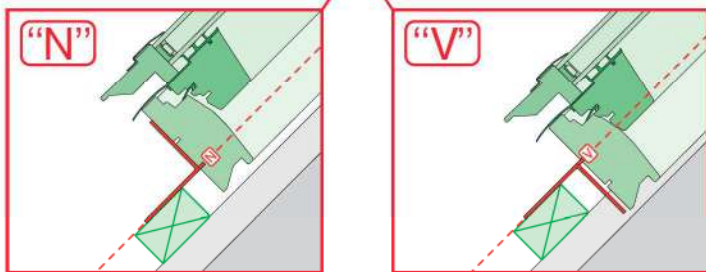
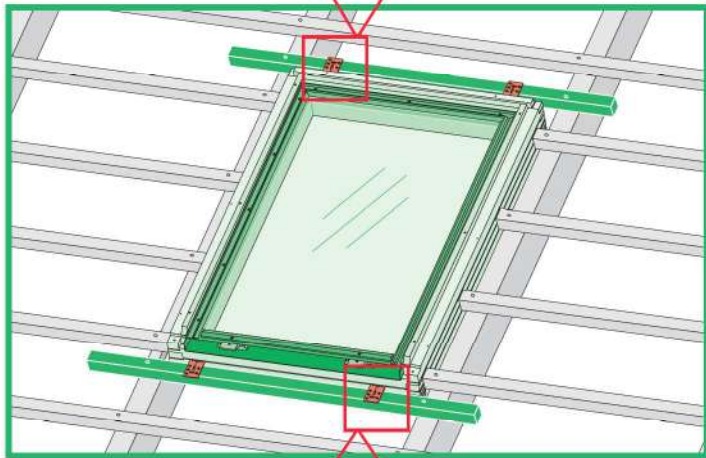
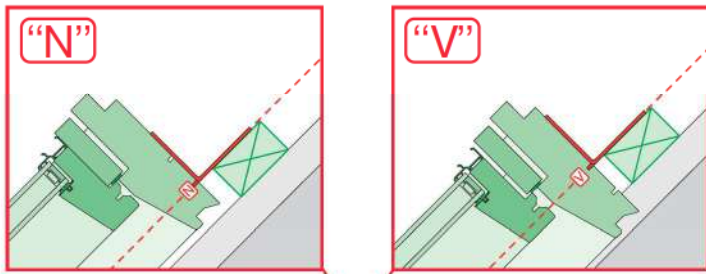

		max 90mm		max 45mm		12-16mm		12-16mm		max 5mm (V) max 15mm (N)	
EHN	7-10cm	EZN	6-8cm	EGV	4cm	ELN	0-2cm	ESN	0-2cm		
EHV	7-10cm	EZV	6-8cm	EPV	6cm	ELV	0-2cm	ESV	0-2cm		
										EEN	
										EEV	
										0-2cm	
										0-2cm	

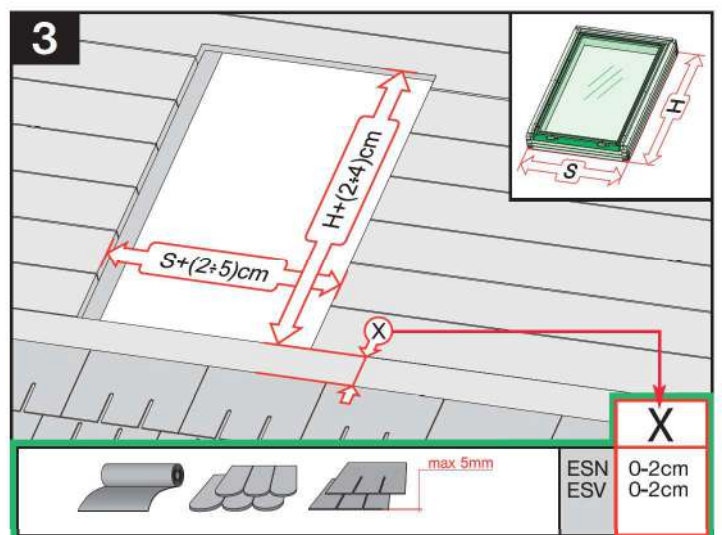

	max 90mm	EHN		
		EHV		
	max 45mm	EZN		
		EZV		
	max 15mm (N) max 5mm (V)	ELN		
		ELV		
	max 5mm	ESN		
		ESV		

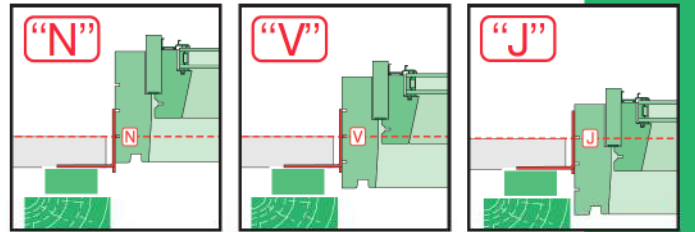
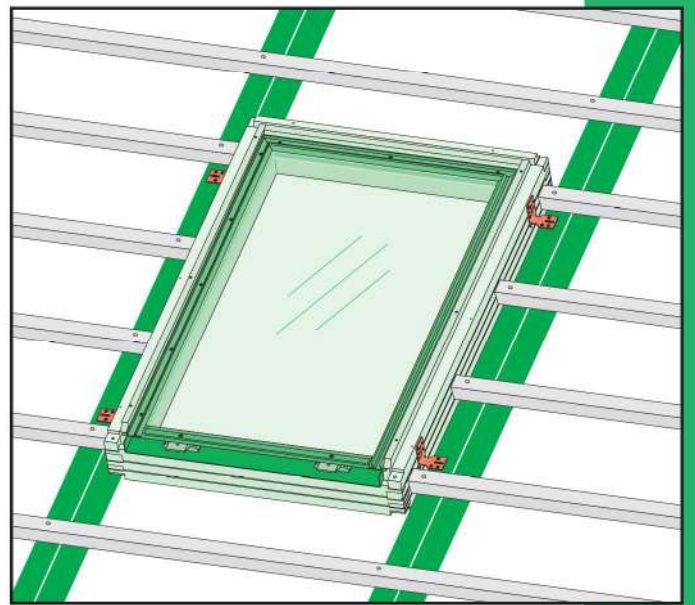
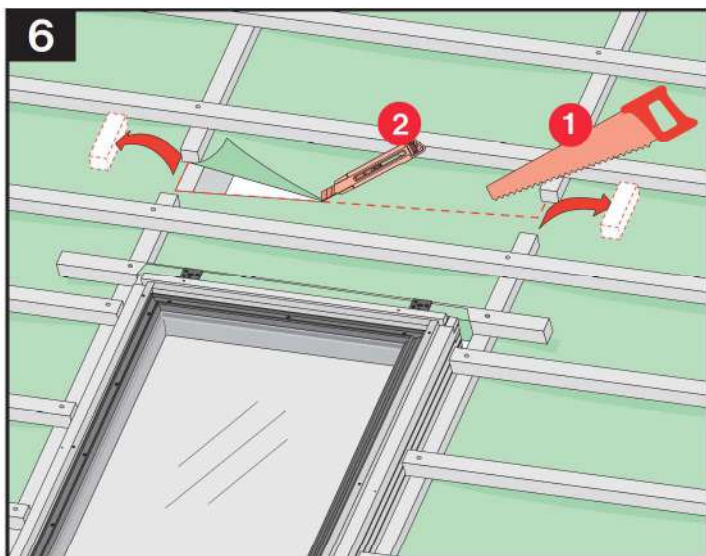
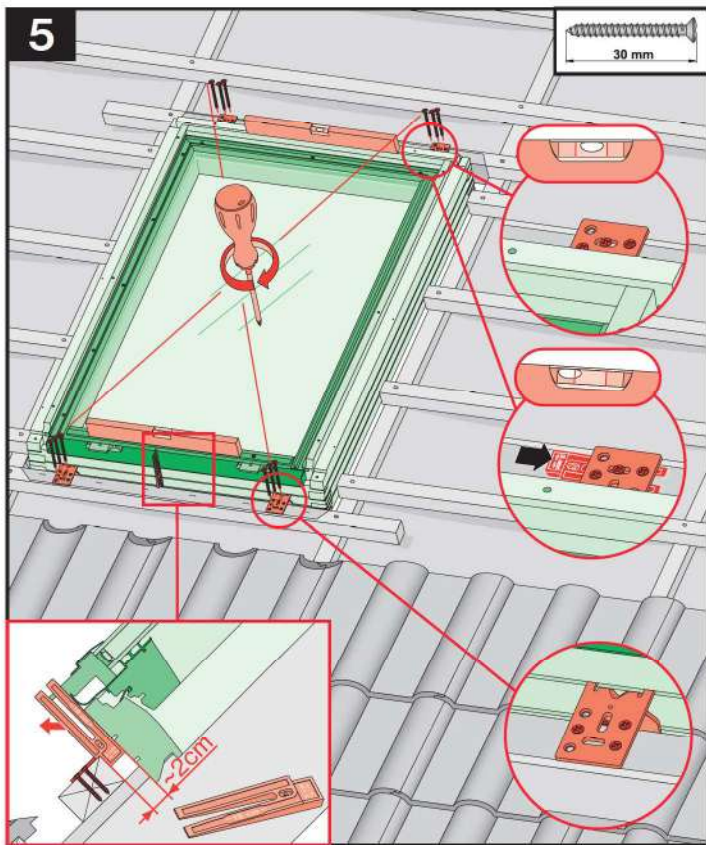
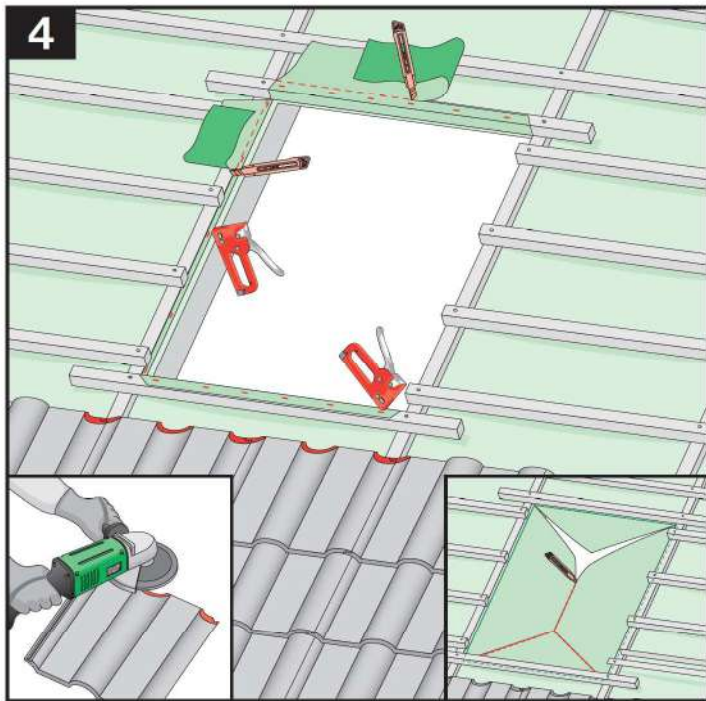

	max 90mm	EHN		
		EHV		
		-	-	-
	max 45mm	EZN		
		EZV		
		EZJ		
	max 15mm (N) max 5mm (V) max 5mm (J)	ELN		
		ELV		
		ELJ		
	max 5mm	ESN		
		ESV		
		ESJ		

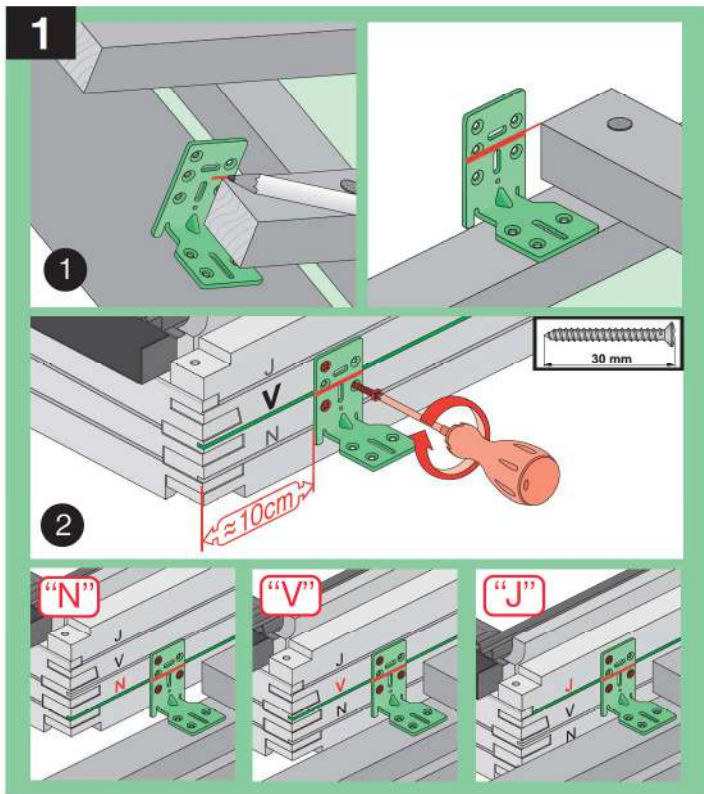

		X
		9-12cm
		8-10cm
		20cm
		6cm
		8cm
		0-4cm
		11cm
		0-4cm
		11cm

		X
		0-4cm
		11cm

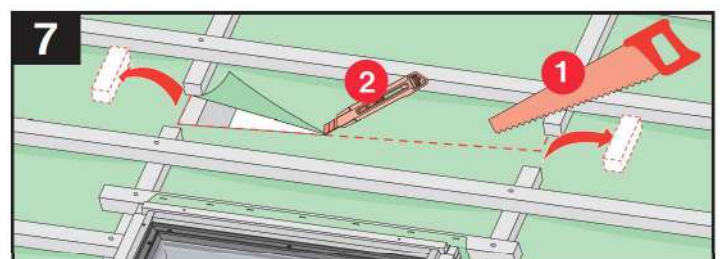
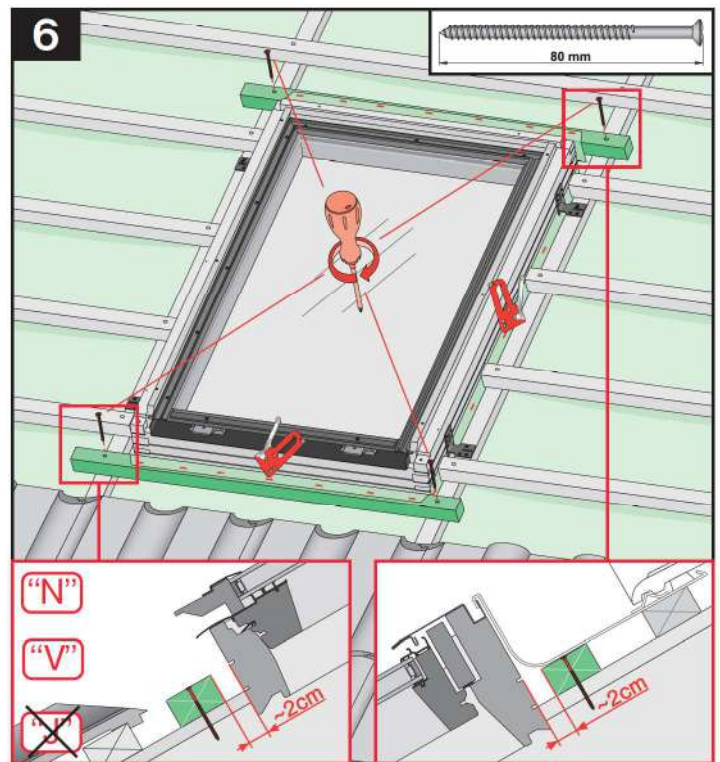
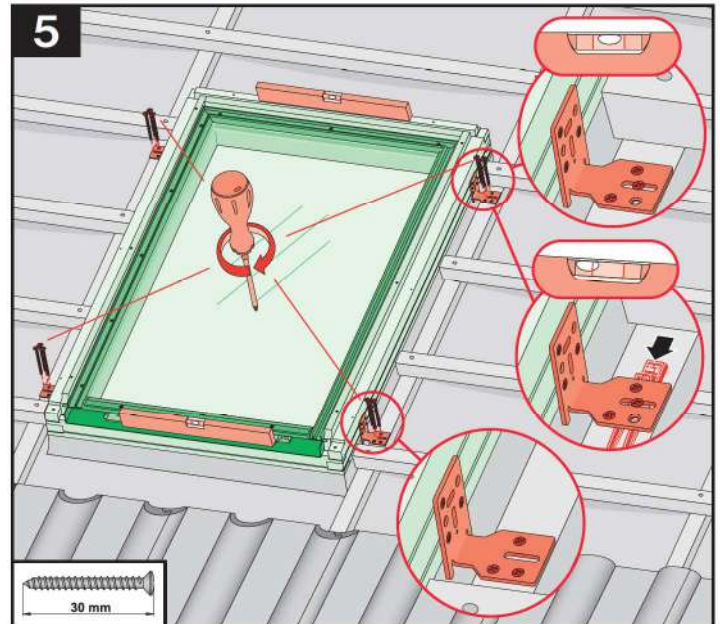
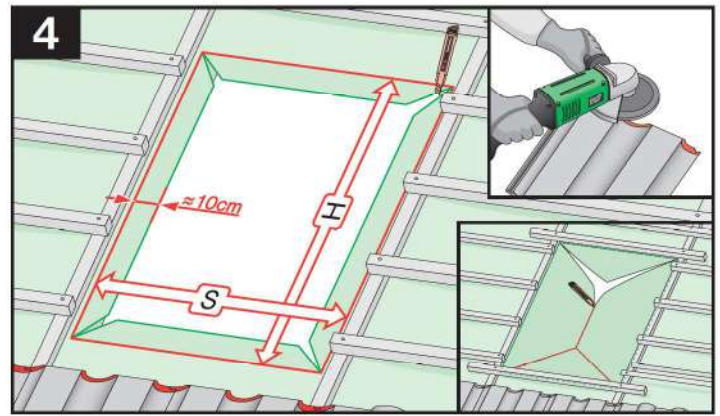

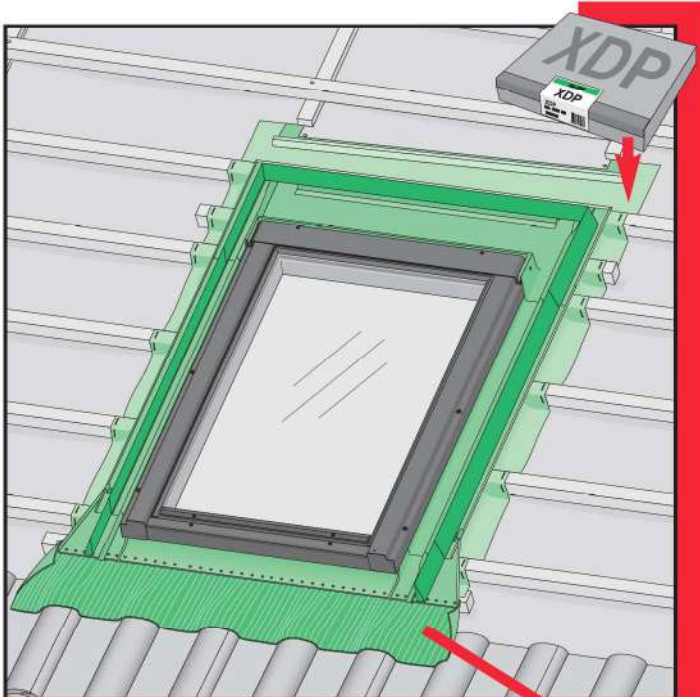

max 90mm	EHN EHV
max 45mm	EZN EZV EZJ
max 5mm	ESN ESV ESJ
300-420mm 12-16mm	EGV
200-280mm max 18mm	EPV
max 5mm (V,J) max 15mm (N)	ELN ELV ELJ
	EEN EEV EEJ

